

Zakład Maszyn Elektrycznych

EMIT S.A.



od 1921 roku

Adam Bron

Tel. 608 34 92 34

E-mail: adam.bron@cantonigroup.com

Cantoni®
GROUP



BESEL S.A.
FABRYKA SILNIKÓW ELEKTRYCZNYCH

CELMA
indukta



Cantoni[®] GROUP

2 dywizje
8 zakładów produkcyjnych

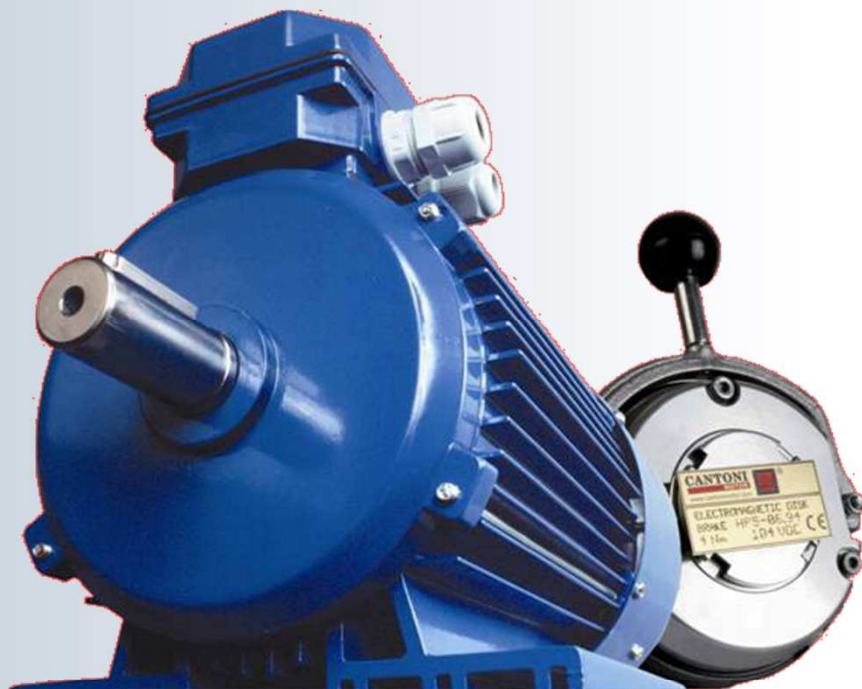

Silniki i komponenty



Narzędzia

Cantoni[®]
GROUP



BESEL S.A.
FABRYKA SILNIKÓW ELEKTRYCZNYCH

CELMA
indukta



Zatrudnienie dywizja silnikowa

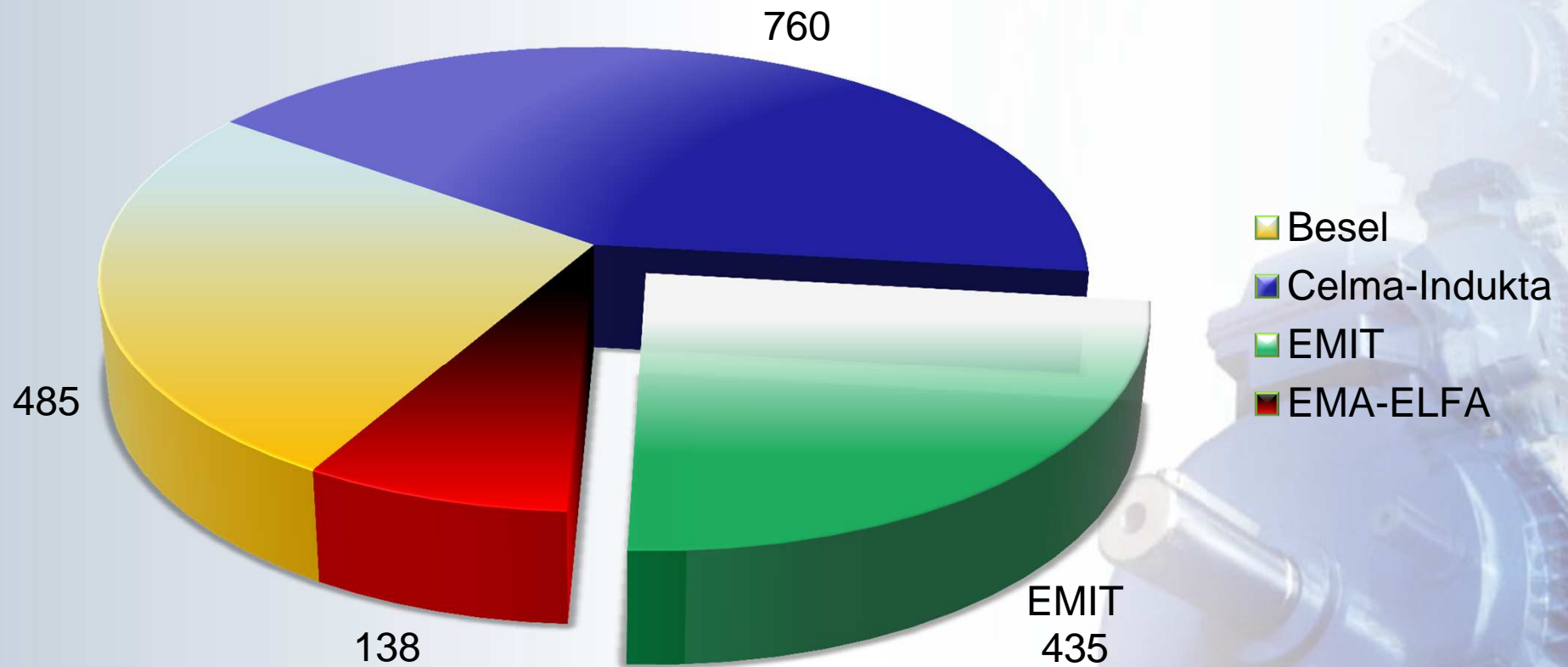

1 i 3-fazowe silniki NN: 0,1÷1,5 kW



3-fazowe silniki NN : 1,5÷200 kW



3-fazowe silniki NN i WN: 160÷6000kW



Cantoni[®]
GROUP



Cantoni[®]
GROUP



BESEL S.A.
FABRYKA SILNIKÓW ELEKTRYCZNYCH

CELMA
i inducta



Historia

POLSKIE ZAKŁADY ELEKTRYCZNE
BROWN BOVERI
SPÓŁKA AKCYJNA
FABRYKA w ŻYCHLINIE



1921

1945

1967

2001

1933

ROHN-ZIELIŃSKI
B R O W N B O V E R I



1997
Elektrim

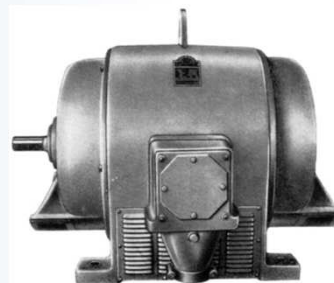

Zmiana zakresu mocy oferowanych silników

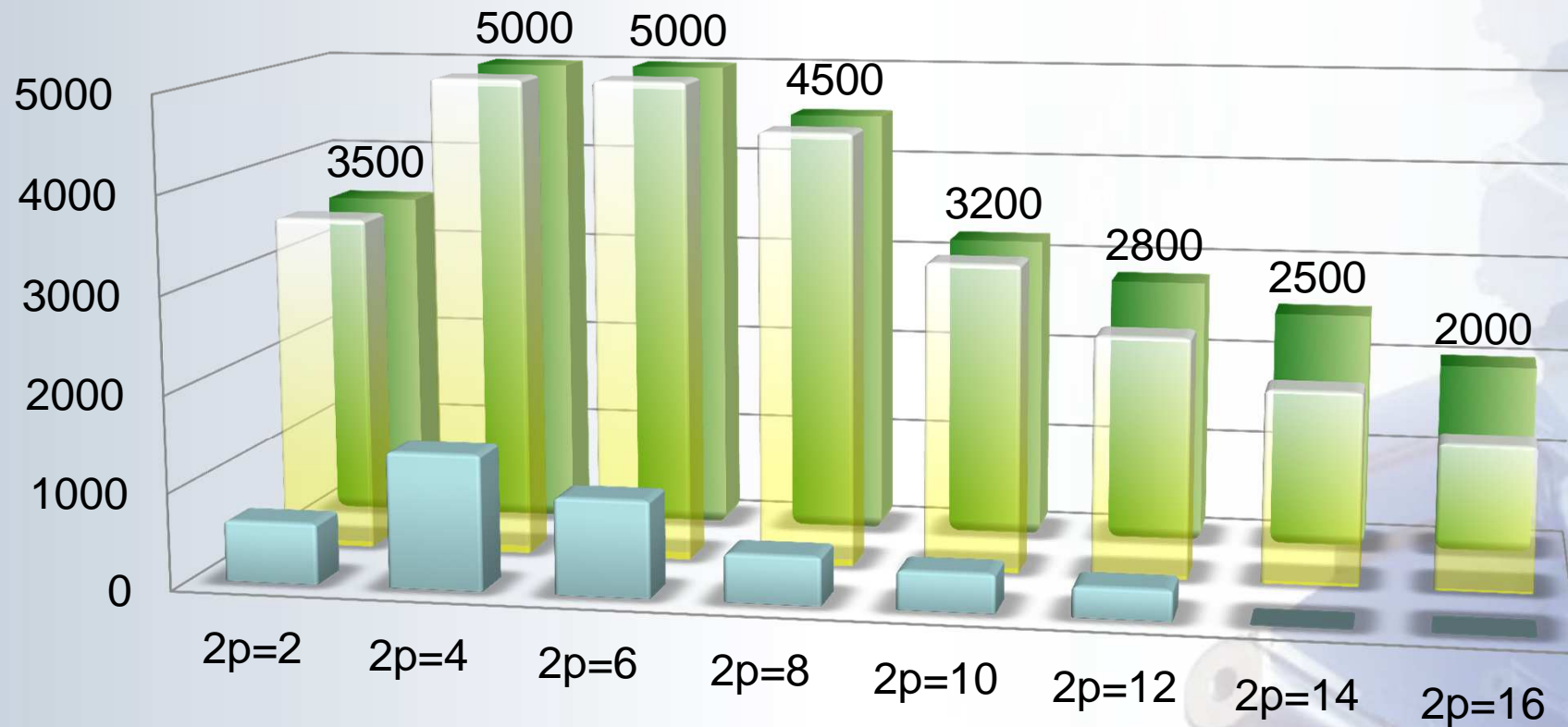

■ 1990-1999 ■ 2012 ■ 2014

Cantoni[®]
GROUP

BESEL S.A.
FABRYKA SILNIKÓW ELEKTRYCZNYCH

CELMA
indukta

EMIT

ELFA

Wielkości mechaniczne oferowanych silników

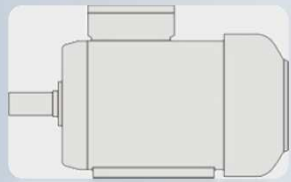

200

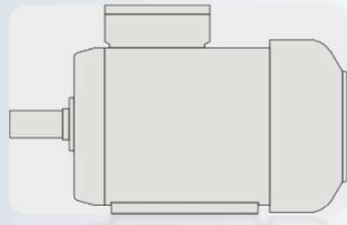

280

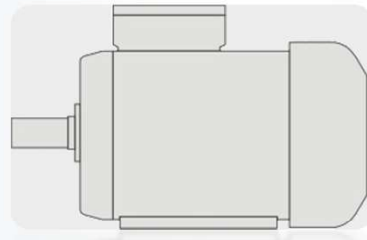

560

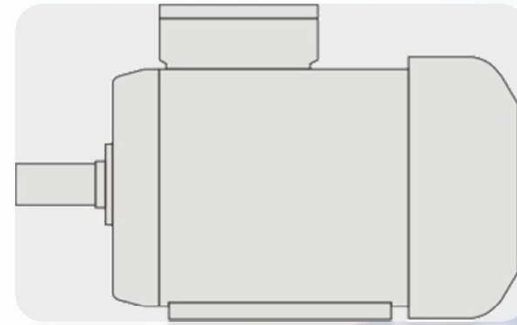

1000

Do
2003
roku

Cantoni®
GROUP



BESEL S.A.
FABRYKA SILNIKÓW ELEKTRYCZNYCH

CELMA
indukta



LOTOS Branże i odbiorcy na rynku krajowym



Eksport

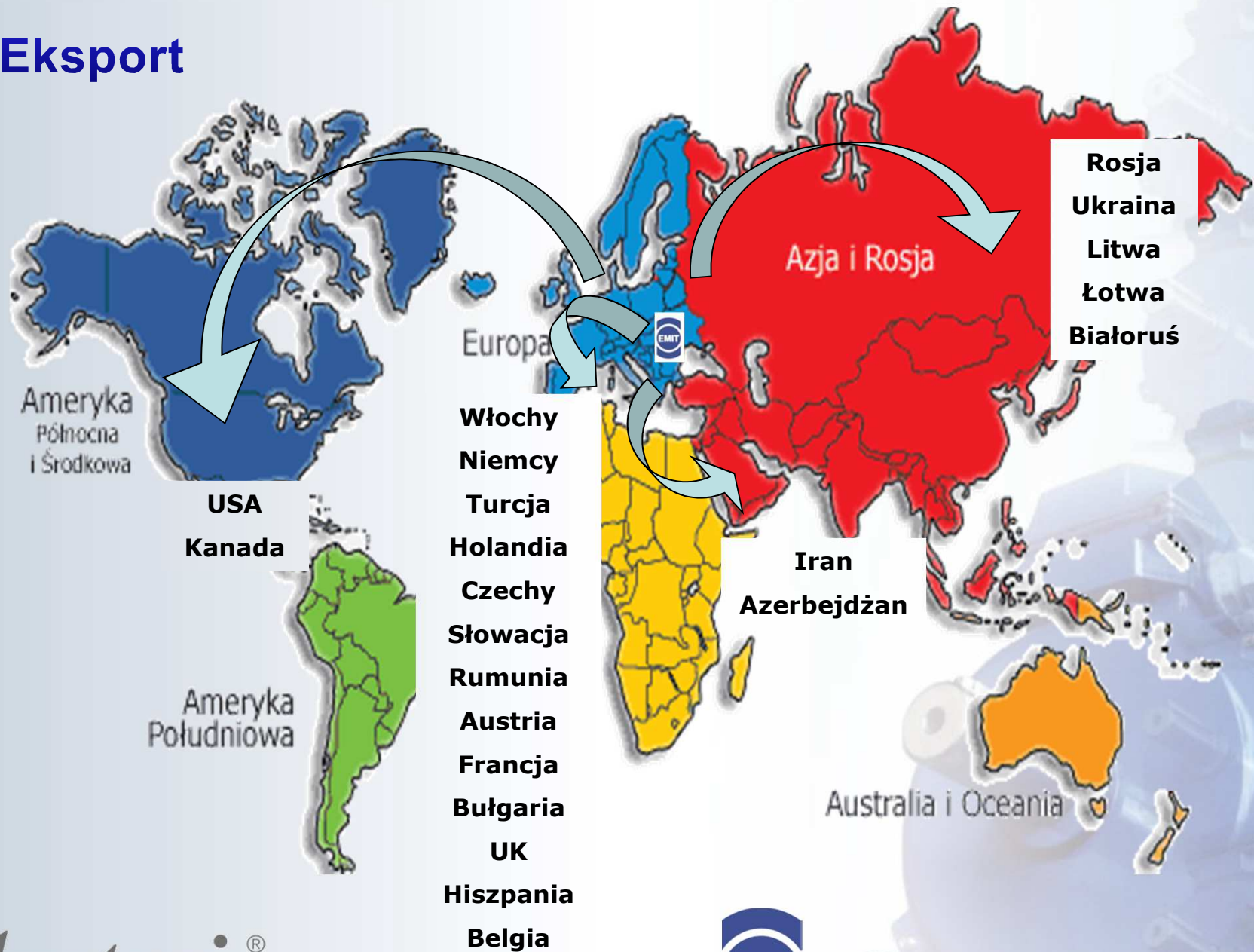

Cantoni®
GROUP

BESEL S.A.
FABRYKA SILNIKÓW ELEKTRYCZNYCH

CELMA
indukta

EMIT

ELFA

Podstawowe serie silników

OFERTA EMIT S.A.



Silniki Średniej i Dużej Mocy Niskiego i Wysokiego Napięcia

Seria Sh

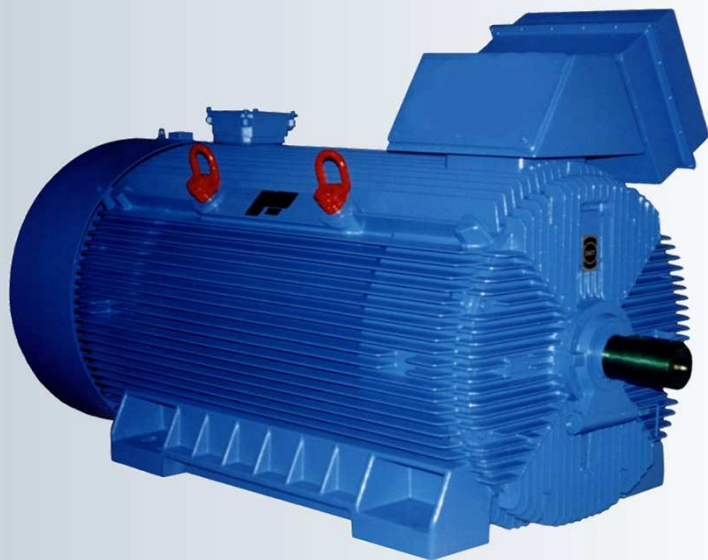

160-1800 kW

Seria Sf(r)



160-5000 kW

Cantoni®
GROUP



BESEL S.A.
FABRYKA SILNIKÓW ELEKTRYCZNYCH

CELMA
indukta



Seria Silników Wysokosprawnych

Zgodnych z normą IEC60034-30



Serie

- 2SIE
- 3SIE

200-375 kW
2-6 biegunów

Cantoni[®]
GROUP



BESEL S.A.
FABRYKA SILNIKÓW ELEKTRYCZNYCH

CELMA
induktora



Silniki Górnicze

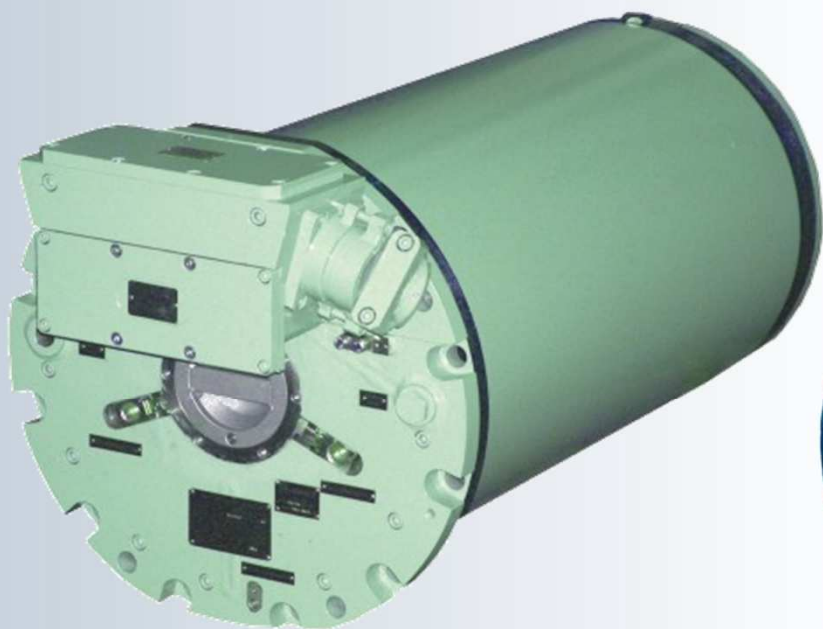

dSKgw
132÷500 kW



dSKGwp
160÷500 kW

Cantoni®
GROUP



BESEL S.A.
FABRYKA SILNIKÓW ELEKTRYCZNYCH

CELMA
indukta



Silniki Przeciwybuchowe Niskiego i Wysokiego napięcia



Cantoni[®]
GROUP



BESEL S.A.
FABRYKA SILNIKÓW ELEKTRYCZNYCH

CELMA
induktka



Silniki Pierścieniowe Niskiego i Wysokiego Napięcia

Seria SU(D)g



45-250 kW

Seria SUf(r)

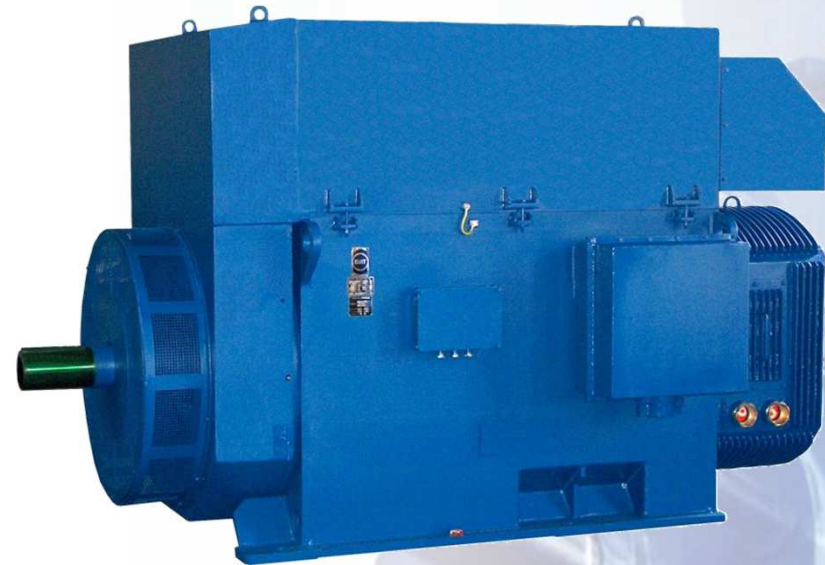

160-2500 kW

Cantoni®
GROUP



BESEL S.A.
FABRYKA SILNIKÓW ELEKTRYCZNYCH

CELMA
indukta



Wykonania Specjalne

OFERTA EMIT S.A.



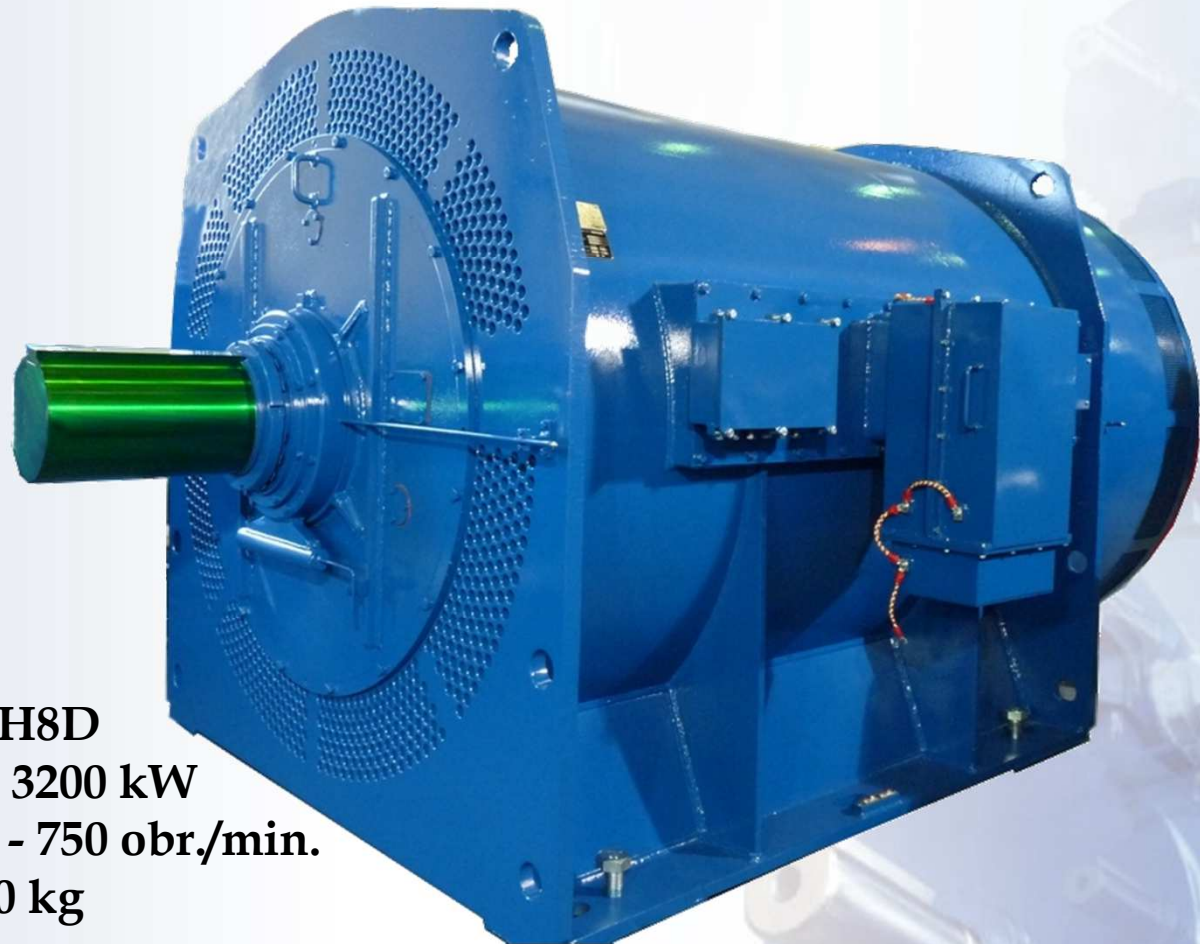

Typ Sfr1000H8D
Moc znamionowa - 3200 kW
Prędkość znamionowa - 750 obr./min.
Masa - 18500 kg
IM 1002

Cantoni®
GROUP



BESEL S.A.
FABRYKA SILNIKÓW ELEKTRYCZNYCH

CELMA
indukta





Typ SVf800Y16B
Moc znamionowa - 1150 kW
Prędkość znamionowa - 372 obr./min. 2p=16
Moment znamionowy - 29522 Nm
Masa - 13400 kg

SVf800Y16B

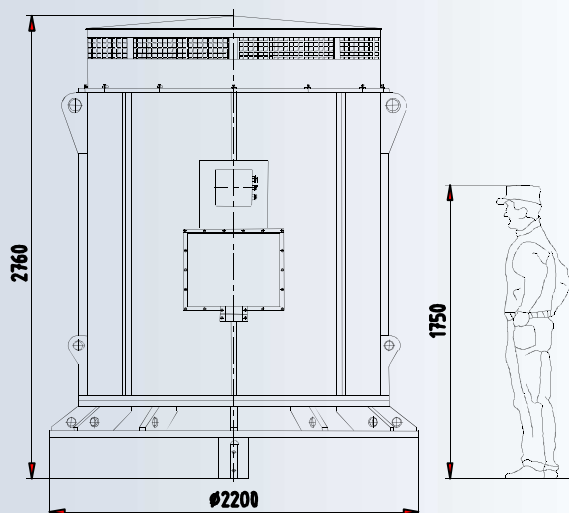

Początek produkcji - 2006r.



Sf710H6DF

Moc- 3400kW

Napięcie - 6000V

Częstotliwość - 50Hz

Stopień ochrony- IP55

Hałas - $\leq 83+2dB(A)$



Cantoni®
GROUP



BESEL S.A.
FABRYKA SILNIKÓW ELEKTRYCZNYCH

CELMA
indukta





Cantoni[®]
GROUP



BESEL S.A.
FABRYKA SILNIKÓW ELEKTRYCZNYCH

CELMA
induktka



3-fazowe silniki elektryczne w wykonaniu przeciwwybuchowym Zasilane napięciem 10kV



Typ: dSh 355 ÷ 500

II 2G EEx de IIB T4

Moc -200 ÷ 820 kW

Napięcie- 10000 V

Cantoni®
GROUP

BESEL S.A.
FABRYKA SILNIKÓW ELEKTRYCZNYCH

CELMA
indukta





Typ: pSf 710Y2-G
II 2G Ex pxe II T3
Moc -1400 kW
Napięcie - 6000 V
Prędkość - 2985 rpm (2p=2)
Masa 9000 kg

Cantoni®
GROUP



BESEL S.A.
FABRYKA SILNIKÓW ELEKTRYCZNYCH

CELMA
indukta



Typ: dSLfr 800H8C-E
EEx d I Mb / Ex d II (CH4) Gb
Moc - 1200 kW
Napięcie - 6000 V
prędkość znamionowa –
746 obr./min
masa 10000 kg



Cantoni®
GROUP



BESEL S.A.
FABRYKA SILNIKÓW ELEKTRYCZNYCH

CELMA
indukta



Typ: dSh 560H4D
II 2G EEx d IIC T4
Мощ - 2000 kW
Napięcie - 6000 V
Prędkość - 1500 obr./min.
Masa - 9400 kg





Typ: dSh 450H2B
II 2G EEx d IIB T4
Мощ - 630 kW
Napięcie - 6000 V
Prędkość - 3000 obr./min.
Masa - 4230 kg



Cantoni®
GROUP

BESEL S.A.
 FABRYKA SILNIKÓW ELEKTRYCZNYCH

CELMA
indukta

EMIT

ELFA

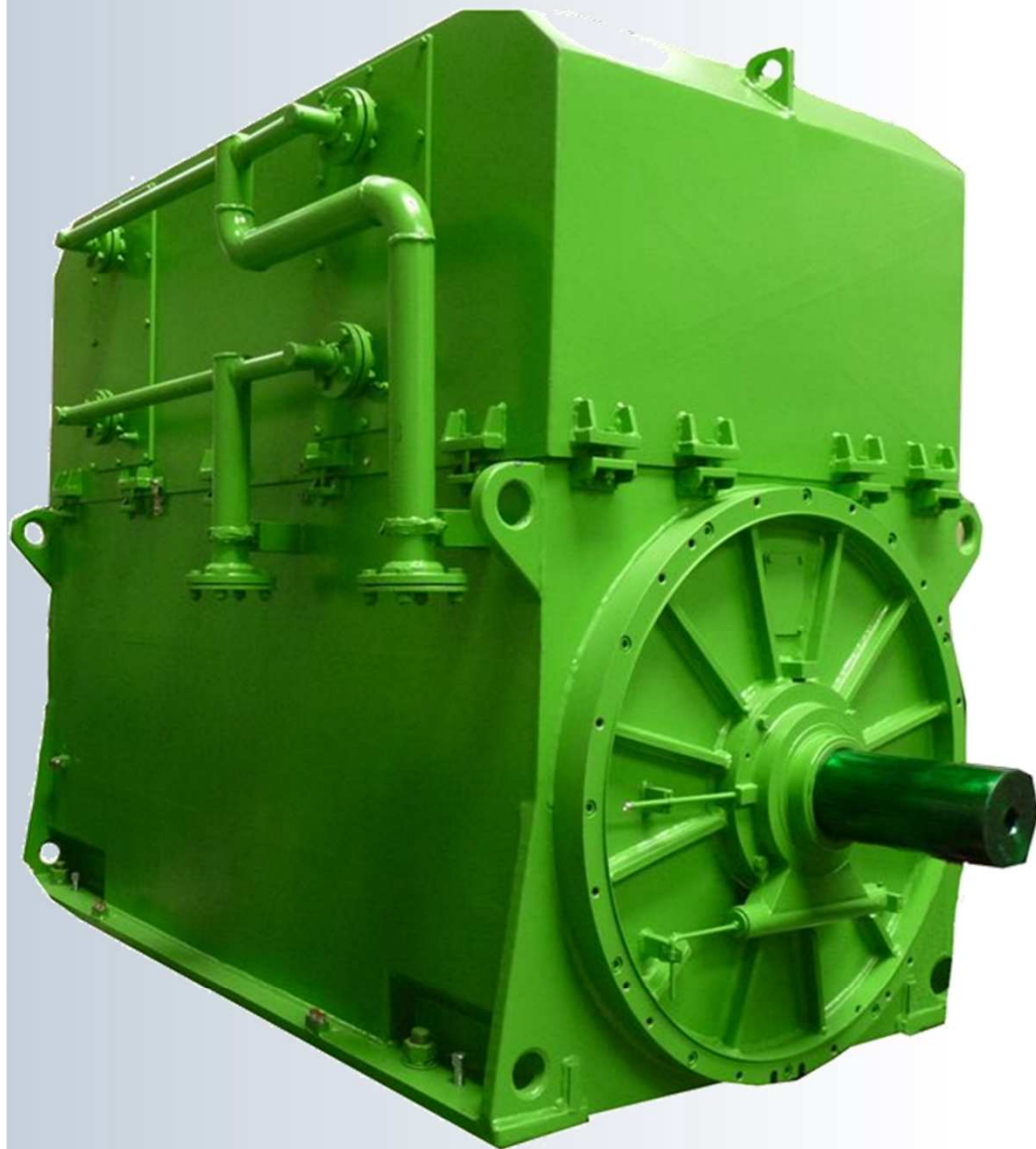

Typ: mSfw560-6Cs
Moc - 2000 kW
Napięcie - 660 V
Prędkość - 1200 obr./min.
Masa - 8600 kg

Cantoni®
GROUP



BESEL S.A.
FABRYKA SILNIKÓW ELEKTRYCZNYCH

CELMA
indukta





**Silniki serii Shz
250÷500 kW, 1500obr/min,
6kV/50Hz, IP68**



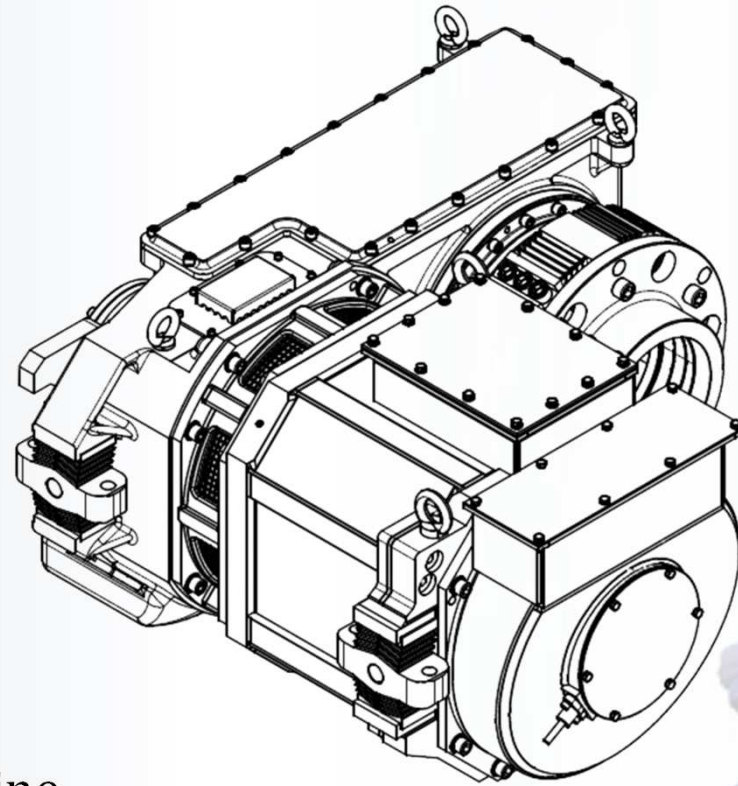

Silniki i generatory trakcyjne

OFERTA EMIT S.A.



Typ – **SXT315-4C**
Moc– 280kW
Napięcie – 2200V



Typ – **SXT355-4A**
Moc– 350kW
Napięcie – 2320V



Cantoni®
GROUP

BESEL S.A.
FABRYKA SILNIKÓW ELEKTRYCZNYCH

CELMA
indukta



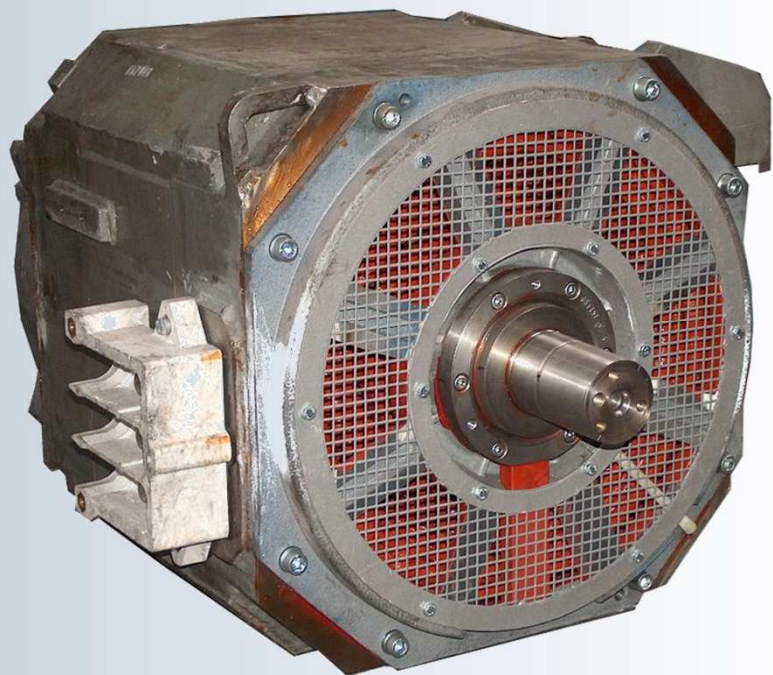

STDa280-4B-UK3
180kW
500V



Cantoni®
GROUP



BESEL S.A.
FABRYKA SILNIKÓW ELEKTRYCZNYCH

CELMA
indukta





GLp 500 L4

S_N - 1572 kVA



Cantoni®
GROUP

BESEL S.A.
FABRYKA SILNIKÓW ELEKTRYCZNYCH

CELMA
indukta



Inwestycje

Inwestycje (tys. PLN)

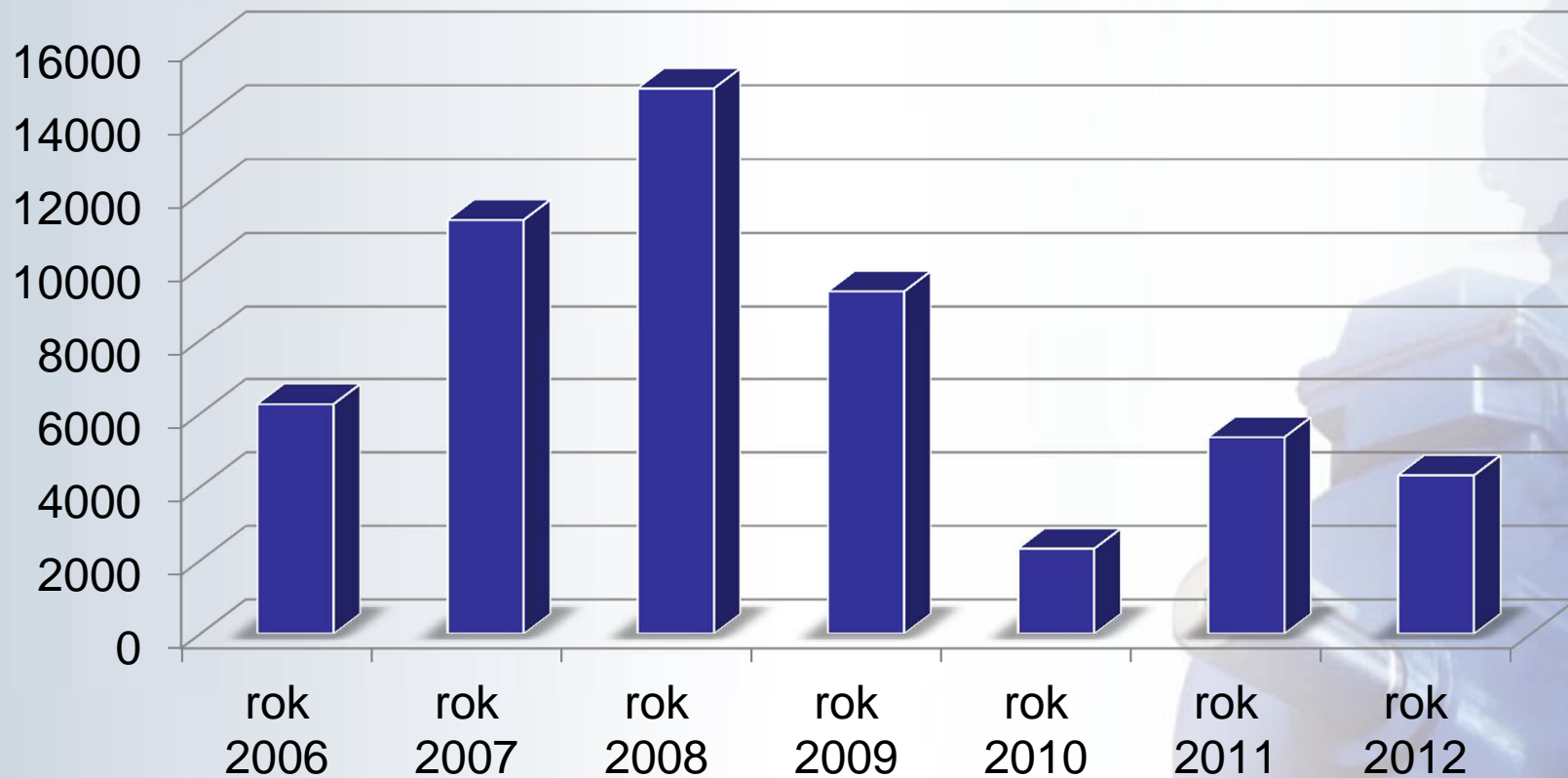

Łącznie: **53.730,2 tys. PLN**



DZIĘKUJĘ ZA UWAGĘ

